

1129
mm.100x22

Cod. CI001129 xxx00

Disponibile in 6 finiture. Vedi aletta di copertina.
Available in 6 finishes. Please see the inside cover flap.
Disponibile in 6 acabados. Ver en la solapa.

Pack. 9

Cerniere invisibili regolabili per porte
Invisible adjustable hinges for doors
Bisagras invisibles ajustables para puertas

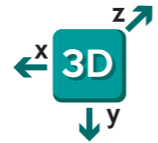

18
DEPTH ONLY

CARATTERISTICHE:

- Realizzata in zama in 6 diverse finiture
- Adatta ad ante con spessore minimo di 28 mm
- Lunghezza totale 100 mm
- Profondità solo **18 mm** "la meno ingombrante sul mercato"
- Regolazione tridimensionale S.T.A.R.S.
- Portata fino a 40 kg
- Easy installation e simmetria di cava

MAIN FEATURES:

- Manufactured in zamak in 6 different finishes
- Suitable for doors of 28 mm min. thickness
- Total length 100 mm
- Depth **18 mm** "the smallest on the market"
- 3D adjusting system S.T.A.R.S.
- Load capacity up to 40 kg
- Easy installation and slot symmetry

CARACTERÍSTICAS:

- Fabricada en zamak en 6 acabados diferentes
- Adapta para puertas con un espesor mínimo de 28 mm
- Longitud total 100 mm
- Profundidad de solamente **18 mm** "la menor en el mercado"
- Ajuste en 3D S.T.A.R.S.
- Capacidad de carga hasta 40 kg
- Easy installation y simetría de corte

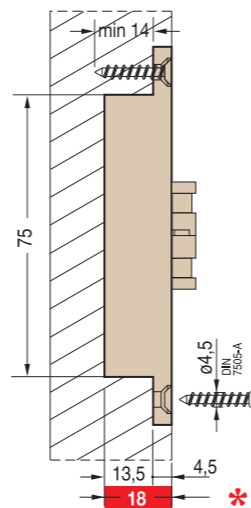
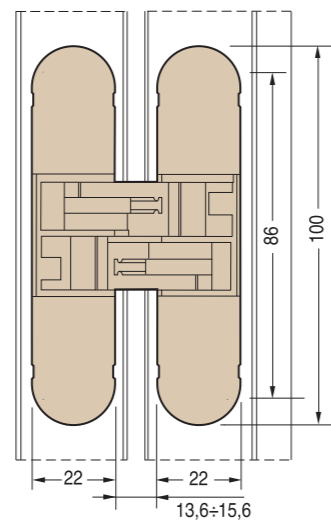
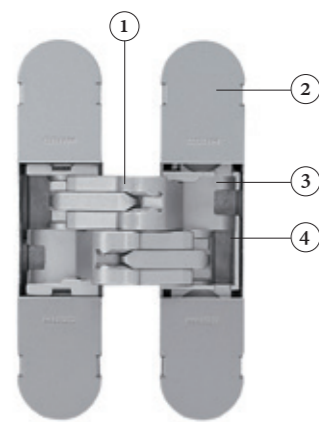

* Profondità di cava contenuta
Small drilling depth
Baja profundidad de corte

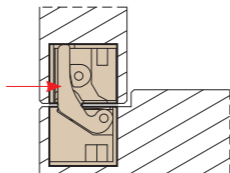
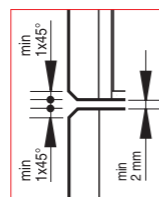
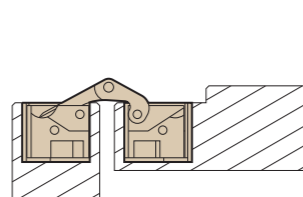

- ① Snodo realizzato in Zama
Machanism manufactured in zinc-alloy
Mecanizado fabricado en zamak
- ② Coperture in acciaio galvanizzato
Galvanized steel covers
Cover en acero galvanizado
- ③ Gabbia interna in Zama
Zinc-alloy internal body
Caja interna en zamak
- ④ Gabbia esterna in Zama
Zinc-alloy external body
Caja externa en zamak

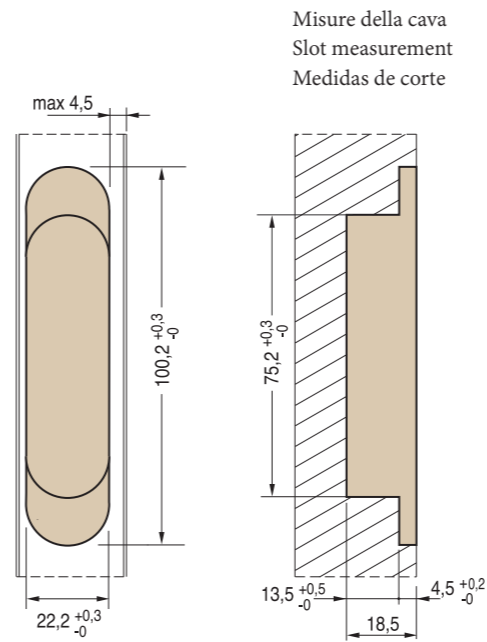

Misure della cava
Slot measurement
Medidas de corte

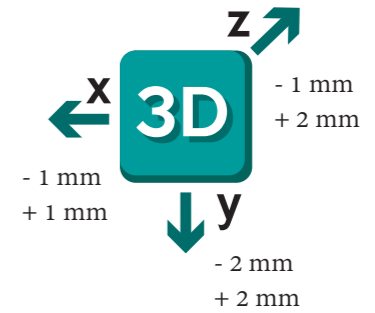

REVERSIBILITÀ - REVERSIBILITY - REVERSIBILIDAD
Reversibile per porte da 28 mm a 31 mm di spessore
Reversible for doors from 28 mm to 31 mm thick
Reversible para puertas de 28 mm hasta 31 mm de espesor

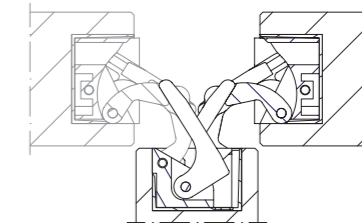

Sezione porta raso senza battuta
Unrebated flush door cross-section
Sección puerta enrasada

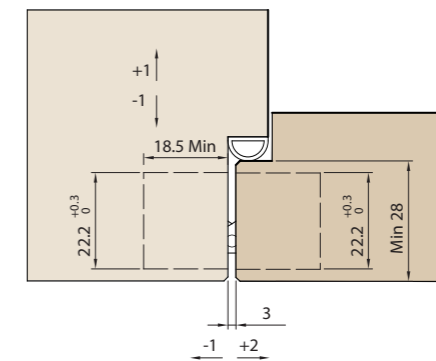
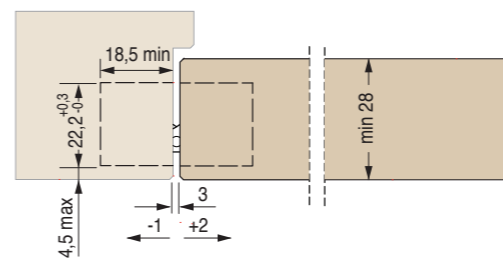

Sezione porta raso con battuta.
Rebated flush door cross-section
Sección puerta enrasada y solapada

SCHEMA DI PORTATA
LOAD CAPACITY CHART
TABLA DE CAPACIDAD DE CARGA

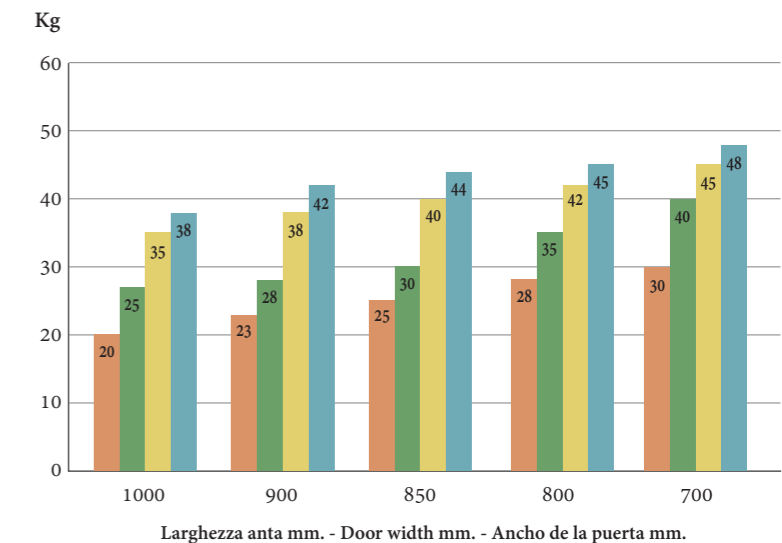
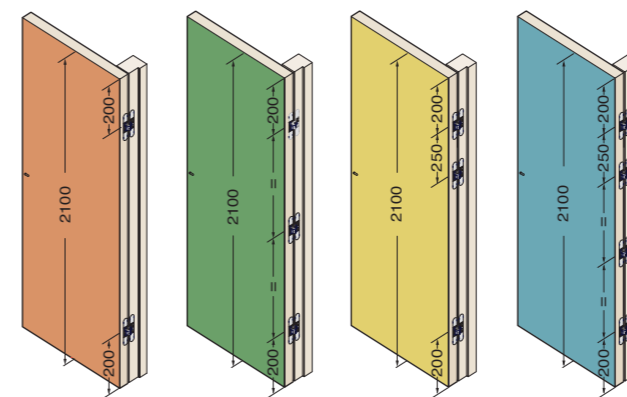

- 2 Cerniere - 2 hinges - 2 bisagras
- 3 Cerniere simmetriche - 3 symmetrical hinges - 3 bisagras simetricas
- 3 Cerniere asimmetriche - 3 asymmetrical hinges - 3 bisagras asimetricas
- 4 Cerniere - 4 hinges - 4 bisagras

Altezza porta 2100 mm; per H. > 2100 o per utilizzi con chiudiporta, consultare pag.92
Door Height 2100mm; for H>2100 or for doorclosers devices please see pag.93
Altura puerta 2100mm; para H>2100 o para usos con cierrapuertas, consultar pag.94

Linee guida di regolazione

Adjustment guidelines
Guía general de ajuste

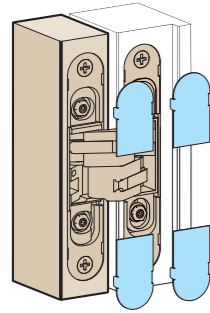

- 1131s
- 1230s
- 1130s
- 1129
- 1030 inox
- 1330s
- 1235s
- 1329
- 1229

Cerniere invisibili regolabili per porte
Invisible adjustable hinges for doors
Bisagras invisibles ajustables para puertas

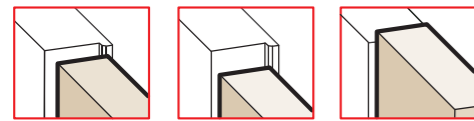
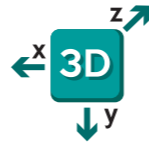

Regolazione verticale
Vertical adjustment
Ajuste vertical

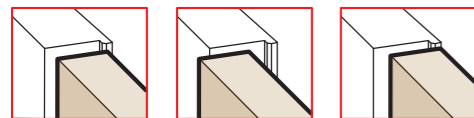
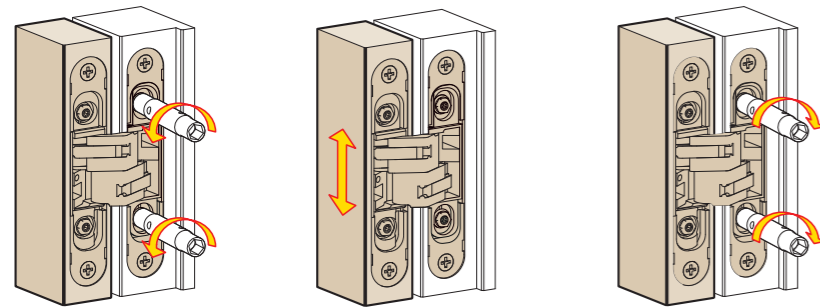
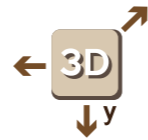

Regolazione orizzontale
Horizontal adjustment
Ajuste horizontal

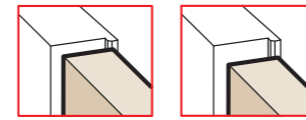
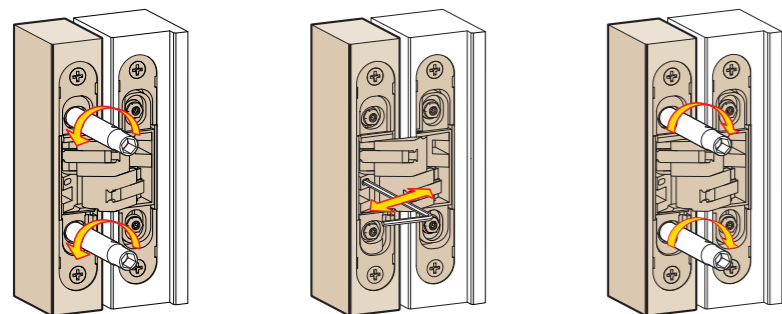
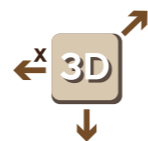

Regolazione in profondità
Depth adjustment
Ajuste de profundidad

