

NEW

1229
mm.100x22

Cod. CI001229 NIK00
Cod. CI001229 ARG00
Cod. CI001229 VNO00

Cerniere invisibili regolabili per porte
Invisible adjustable hinges for doors
Bisagras invisibles ajustables para puertas

Pack. 72

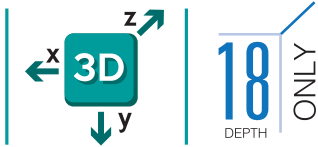

CARATTERISTICHE:

- Il giusto compromesso tra resistenza e leggerezza: 1229 è il modello "ibrido" realizzato principalmente in Zama con gabbie interne in fibra di vetro
- Adatta per ante con spessore minimo di 28 mm
- Lunghezza totale 100 mm
- Profondità solo **18 mm** "la meno ingombrante sul mercato"
- Regolazione tridimensionale S.T.A.R.S.
- Portata fino a 35 kg
- Easy installation e simmetria di cava
- Resistente e Ultralight: solo 209 g

MAIN FEATURES:

- The perfect compromise between strength and lightness: 1229 is the "hybrid" model, mainly manufactured in zamak with internal body in fibreglass
- Suitable for doors of 28 mm min. thickness
- Total length 100 mm
- Depth **18 mm** only "the smallest on the market"
- 3D adjusting system S.T.A.R.S.
- Load capacity up to 35 kg
- Easy installation and slot symmetry
- Tough and Ultralight: just 209 g

CARACTERÍSTICAS:

- El perfecto compromiso entre fuerza y levedad: 1229 es el modelo "ibrido" hecho principalmente de zamak con cajas internas en fibra de vidrio.
- Adapta para puertas con un espesor mínimo de 28 mm
- Longitud total 100 mm
- Profundidad de solamente **18 mm** "la menor en el mercado"
- Ajuste en 3D S.T.A.R.S.
- Capacidad de carga hasta 35 kg
- Easy installation y simetría de corte
- Resistente y Ultralight: solamente 209 g

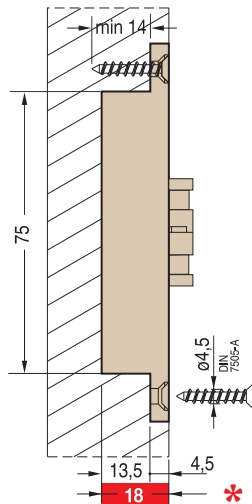
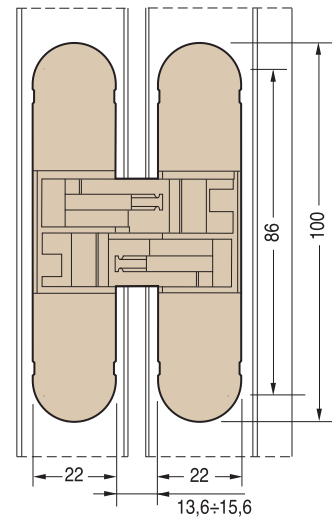
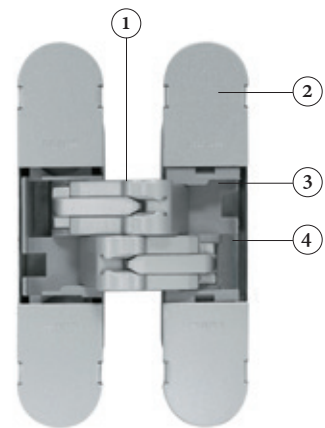

* Profondità di cava contenuta
Small drilling depth
Baja profundidad de corte

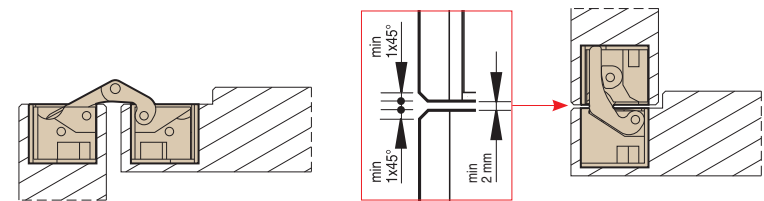

- ① Snodo realizzato in Zama
Mechanism manufactured in zinc-alloy
Mecanizado fabricado en zamak
- ② Covers in acciaio galvanizzato
Galvanized steel covers
Cover en acero galvanizado
- ③ Gabbia interna in fibra di vetro
Fibreglass internal body
Caja interna en fibra de vidrio
- ④ Gabbia esterna in Zama
Zinc-alloy external body
Caja externa en zamak

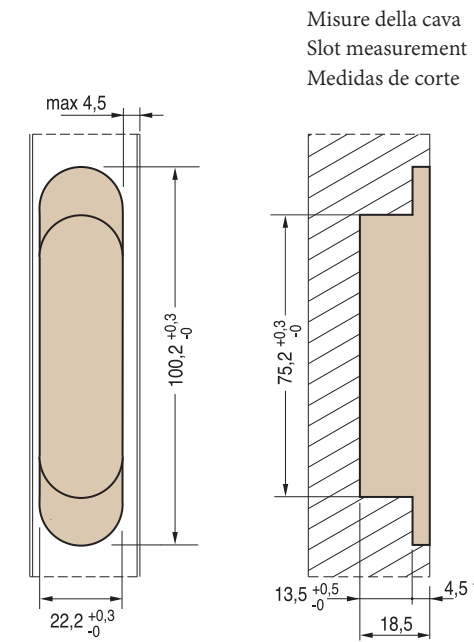

Misure della cava
Slot measurement
Medidas de corte

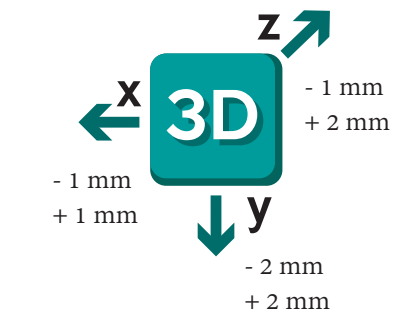

REVERSIBILITÀ - REVERSIBILITY - REVERSIBILIDAD

Reversibile per porte da 28 mm a 31 mm di spessore
Reversible for doors from 28 mm to 31 mm thick
Reversible para puertas de 28 mm hasta 31 mm de espesor

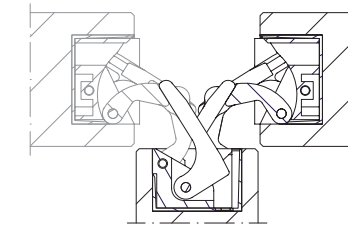

Sezione porta raso senza battuta
Unrebated flush door cross-section
Sección puerta enrasada

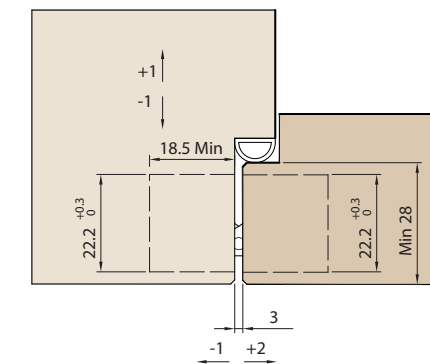
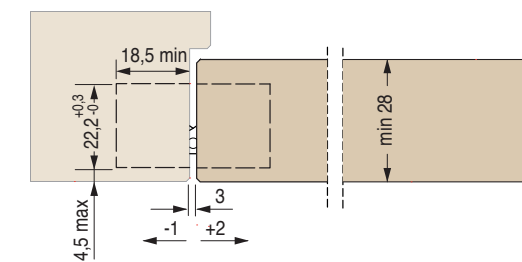

Sezione porta raso con battuta
Rebated flush door cross-section
Sección puerta enrasada y solapada

SCHEMA DI PORTATA
LOAD CAPACITY CHART
TABLA DE CAPACIDAD DE CARGA

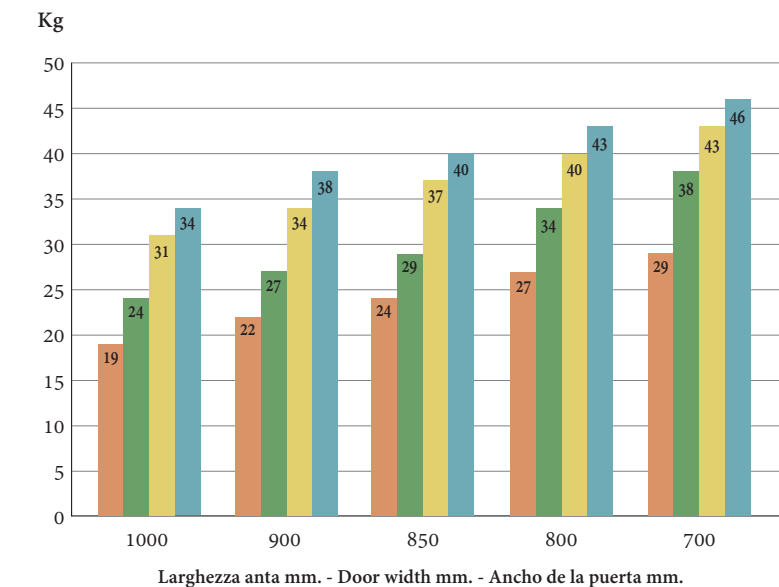
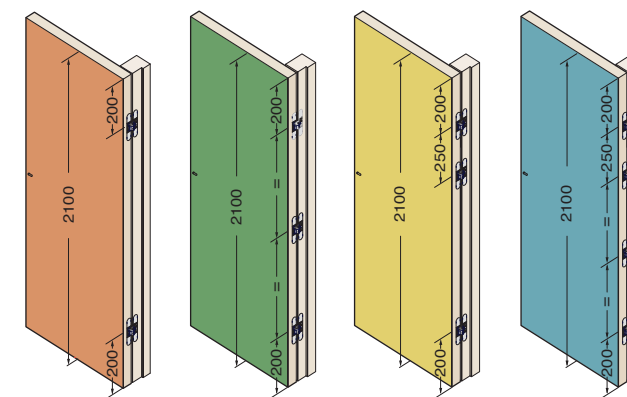

- 2 Cerniere - 2 hinges - 2 bisagras
- 3 Cerniere simmetriche - 3 symmetrical hinges - 3 bisagras simetricas
- 3 Cerniere asimmetriche - 3 asymmetrical hinges - 3 bisagras asimetricas
- 4 Cerniere - 4 hinges - 4 bisagras

Altezza porta 2100 mm; per H. > 2100 o per utilizzi con chiudiporta, consultare pag.92

Door Height 2100mm; for H>2100 or for doorclosers devices please see pag.93

Altura puerta 2100mm; para H>2100 o para usos con cierrapuertas, consultar pag.94

Linee guida di regolazione

Adjustment guidelines
Guía general de ajuste

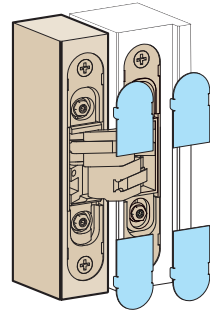

- 1131s
- 1230s
- 1130s
- 1129
- 1030 inox
- 1330s
- 1235s
- 1329
- 1229

Cerniere invisibili regolabili per porte
Invisible adjustable hinges for doors
Bisagras invisibles ajustables para puertas

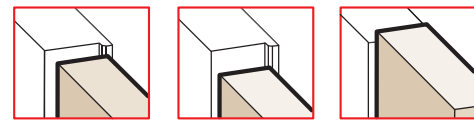
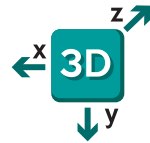

Regolazione verticale
Vertical adjustment
Ajuste vertical

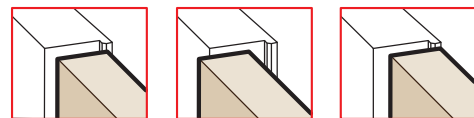
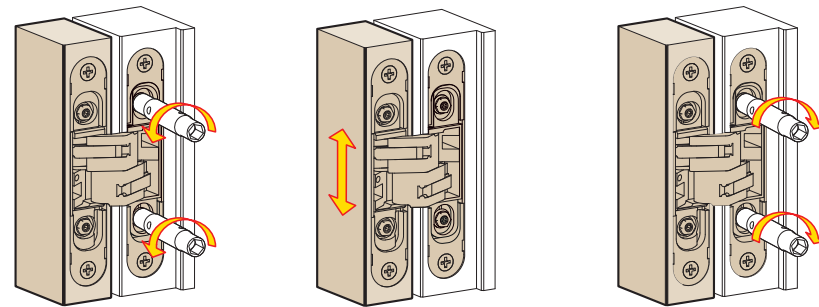
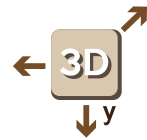

Regolazione orizzontale
Horizontal adjustment
Ajuste horizontal

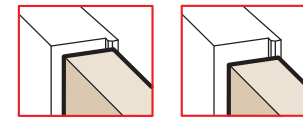
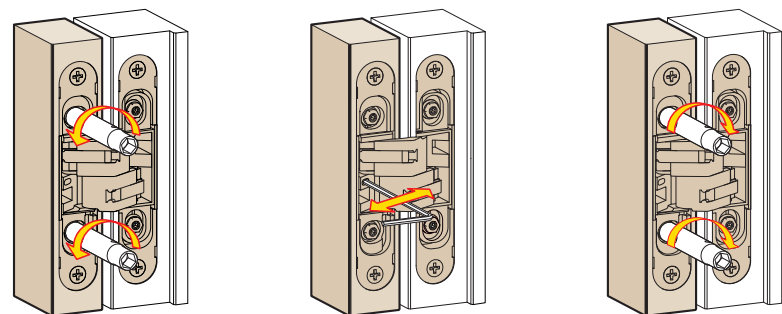
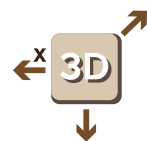

Regolazione in profondità
Depth adjustment
Ajuste de profundidad

